

# 東莞永力電業有限公司

YUNG LI CO., LTD

Da Pu Industrial Zone, Gang Zi, Changping Town,  
Dong Guan City, Guangdong 523571 China.P.R.C

TEL:0769-83396797~8

FAX:0769-83396796

E-mail: sales@yung-li.com

Description: YP-12/YC-12

Customer: MAG

Parts No. : CB-N-JUS

Draw No. :

## *REVISION RECORD*

1		
2		
3		
4		
5		

YUNG LI	
CHECKED	PREPARED BY

CUSTOMER	APPROVED

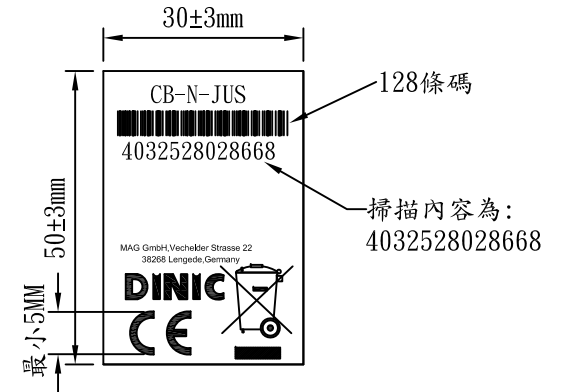
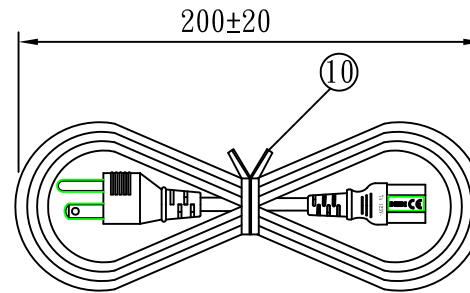
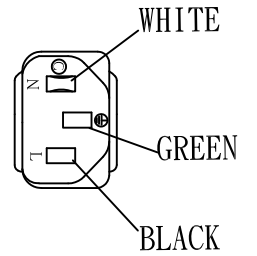
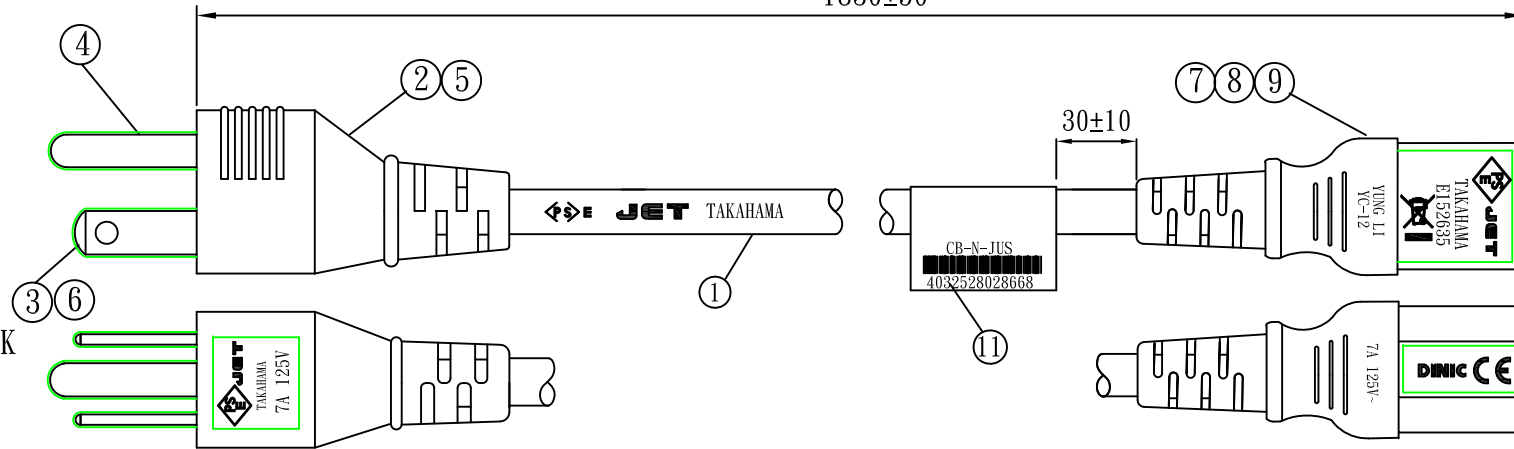
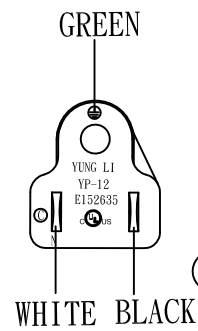

NO.	SPECIFICATION	QTY	REMARK
1	PSE:VCTF 0.75/3C&SJT 18/3C 105 °C BLACK	1PC	1820±15(YL)
2	YP-12 PVC PLASTIC 35P BLACK	19g/PC	
3	TERMINAL:97675BS-1	2PCS	
4	∅4.75 TERMINAL:98475	1PC	
5	YP-12 INNER BODY	1PC	
6	SLEEVE WHITE	1PC	
7	YC-12 PVC PLASTIC 50P BLACK	18g/PC	
8	U-TYPE TERMINAL:97740	3PCS	
9	YC-12 INNER BODY	1PC	
10	MINI TIE BLACK	1PC	
11	label:50*30mm	1PC	

MARKING:

<PS>E JET TAKAHAMA VCTF 3G 0.75mm<sup>2</sup> 20XX -F-  
 YUNG LI. c(UL)us E241374 SJT 3/C 18AWG(0.824mm<sup>2</sup>) 105°C 300V VW-1

Tolerance >0±0.30 >1.0±0.50 >10.0±1.0 >20.0±2.0 Angle: ±1°	Approved		Date	YUNG LI CO., LTD				
	Checked		Date					
	Drawn	SUKI	Date	23.10.24	Customer	MAG		
	Cat. No.	YP-12/YC-12			P/N.	CB-N-JUS		
	Drawing No.	CY-P0894-01		Rev.	B	Material	P.V.C	Unit

128條碼  
 掃描內容為:  
 4032528028668

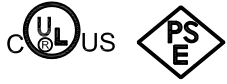

NEMA 5-15P

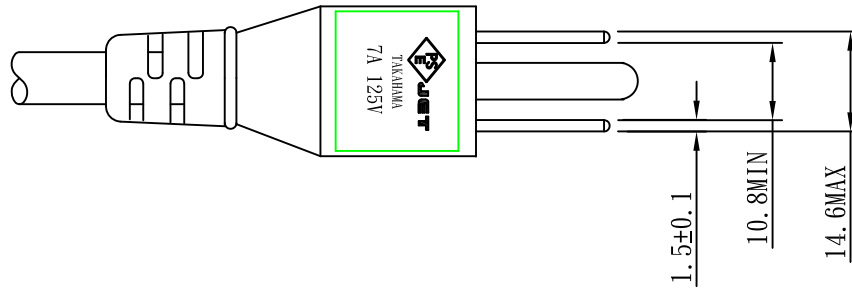
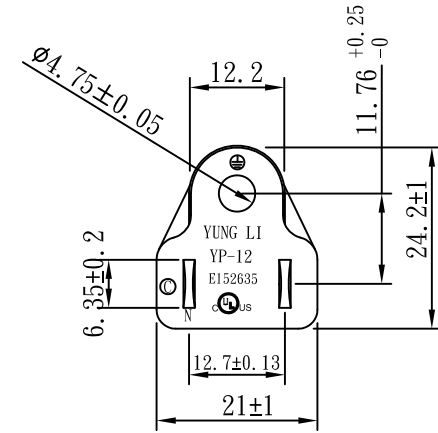
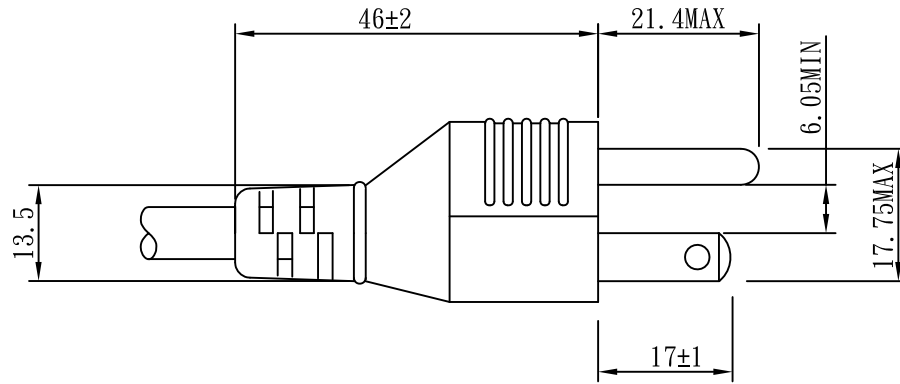

TOLERANCE >0±0.30 >1.0±0.50 >10.0±1.0 >20.0±2.0 Angle: ±1°	APPROVED		DATE		YUNG LI CO., LTD			
	CHECKED		DATE					
	DRAWN		DATE					
	TYPE	YP-12			P/N			
	DRAWING NO.		REV	B	SCALE	1:1	UNIT	mm

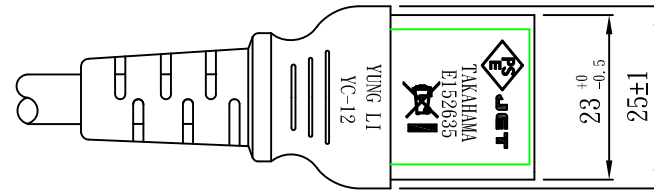
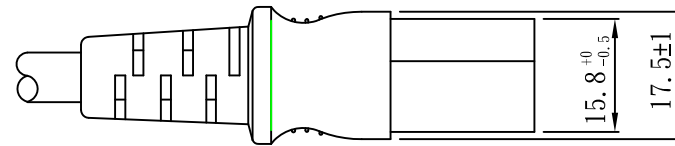
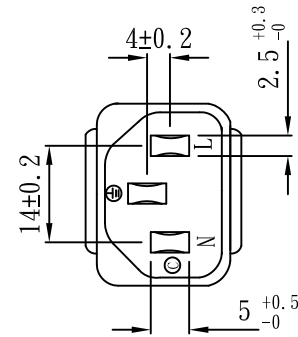
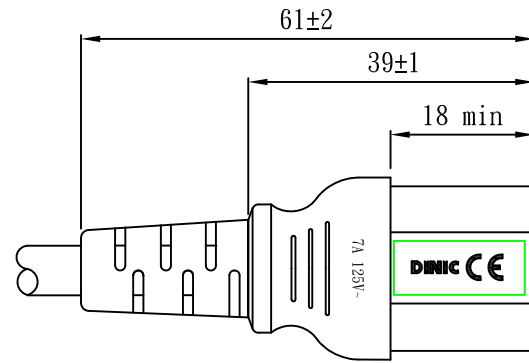

TOLERANCE >0±0.30 >1.0±0.50 >10.0±1.0 >20.0±2.0 Angle: ±1°	APPROVED		DATE		YUNG LI CO., LTD			
	CHECKED		DATE					
	DRAWN	SUKI	DATE	23.10.24				
	TYPE	YC-12			P/N			
	DRAWING NO.		REV	B	SCALE	1:1	UNIT	mm

# YUNG LI CO., LTD

## SPECIFICATION

Yung-Li	Style	PVC FLEXIBLE CORDS	Document No
2010.06.22			
Edition	Size	PSE VCTF 3G 0.75mm <sup>2</sup> &SJT 18/3C 105	Page
A			1/2

1. Standard: JIS C3166 UL62

2. Construction & Dimension

	Item	Specification
Conductor	Size	18AWG
	Material	Annealed Bare Copper
	Construction	41/ 0.16mm±0.003
Insulation	Material	PVC
	Minimum Average Thickness	0.69mm
	Minimum Thickness at any point	0.76mm
	Diameter	2.75 ± 0.10mm
	Identification	Black, White, Yellow/Green
Core Assembly	Core Twist	3-Core
	Filler	NA
	Assembly Pair	NA
Taping	Mylar Foil	NA
Shielded	A1-Mylar Foil	NA
Drain	Material	NA
	Construction	NA
Jacket	Material	PVC
	Minimum Average Thickness	0.9mm
	Minimum Thickness at any point	0.7mm
	Overall Diameter(Approx)	7.9 ± 0.15mm
	Color	Any Color

### Marking:

<PS>E JET TAKAHAMA VCTF 3G 0.75mm<sup>2</sup> 20XX -F-

YUNG LI. c(UL)us E241374 SJT 3/C 18AWG(0.824mm<sup>2</sup>) 105 300V VW-1

# YUNG LI CO., LTD

## SPECIFICATION

Yung-Li	Style	PVC FLEXIBLE CORDS	Document No
2010.06.22			
Edition	Size	PSE VCTF 3G 0.75mm <sup>2</sup> &SJT 18/3C 105	Page
A			2/2

### 3. Electrical & Physical Properties

Item	Specification		
Rating Voltage	300V		
Conductor resistance(AT 20 )	25.1 /Km MAX		
Insulation Resistance(AT 20 )	5.0M /Km Min		
Dielectric Strength	AC 1.5 KV / 1min No Break		
Spark Test	5KV/0.15sec		
Insulation	Unaged	Tensile Strength	1.02 kgf/mm <sup>2</sup> min
		Elongation	100% Min
	Aged	Tensile Strength	Min 85% (136 x168hrs)
		Elongation	Min 80% (136 x168hrs)
Jacket	Unaged	Tensile Strength	1.02 kgf/mm <sup>2</sup> min
		Elongation	100% Min
	Aged	Tensile Strength	Min 85% (136 x168hrs)
		Elongation	Min 80% (136 x168hrs)
Deformation Test	120±3 m X 1hr 50%		
Cold Bend Test	-20 ± x 1hr No Crack		
Heat Shock Test	120±3 x 1hr No Crack		

### Graph:

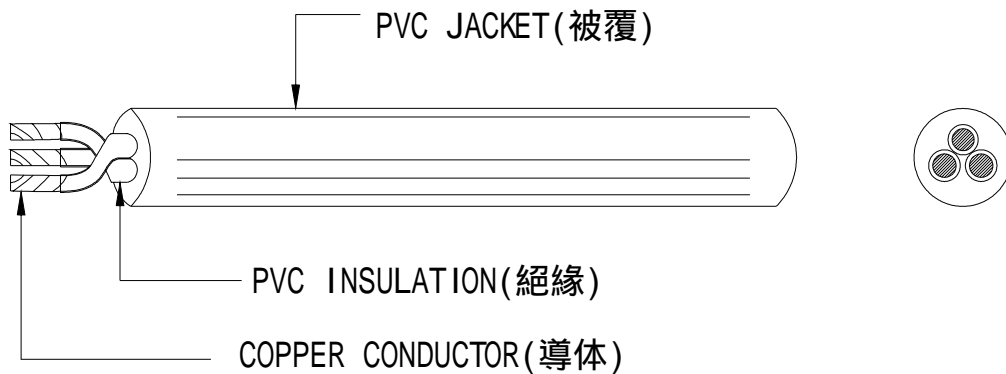



# ELBZ7.E152635 - Cord Sets and Power-supply Cords Certified for Canada

## Cord Sets and Power-supply Cords Certified for Canada

[See General Information for Cord Sets and Power-supply Cords Certified for Canada](#)

**YUNG LI CO LTD**

7F-12 NO 99 SEC 1 XINTAI 5TH RD  
XIZHI DISTRICT  
NEW TAIPEI, 22175 TAIWAN

E152635

**Power-supply cords**

Cat. No.	ANSI/NEMA Cord WD6 Config	Cord AWG	Cord Type	Electrical Rating Amps V
YP-11	1-15	18/2	SPT-1, SPT-2, SPT-3, NISPT-2, SVT, SVTO, SJT, SJTW, SJTO, SJTOW (All TPE material), SPT-1, SPT-1W, NISPT-1, SPT-2, SPT-2W, NISPT-2, SPT-3, HPN, SVT, SVTO, SJT, SJTW, SJTO, SJTOW, SV, SVO, SJ, SJO, SJOW, SJOOW, EVT, EVJT, EVE, EVJE	7 or 10/125
		17/2	SVT, SVTO (All TPE material), SVT, SVTO, SV, SVO, SJ, SJO, SJOW, SJOOW, EVT, EVJT, EVE, EVJE	12/125
		16/2	SPT-2, SPT-3, NISPT-2, SVT, SVTO, SJT, SJTW, SJTO, SJTOW (All TPE material), SPT-2, SPT-2W, NISPT-2, SPT-3, SVT, SVTO, SJT, SJTW, SJTO, SJTOW, SV, SVO, SJ, SJO, SJOW, SJOOW, EVT, EVJT, EVE, EVJE	13/125
		16/2	HPN	15/125
		14/2	SPT-3, SJT, SJTW, SJTO, SJTOW (All TPE material), SPT-3, SJT, SJTW, SJTO, SJTOW, SJ, SJO, SJOW, SJOOW, EVT, EVJT, EVE, EVJE	15/125
YP-11W	1-15P	18/2	SPT-1, SPT-2, SPT-3, NISPT-2, SVT, SVTO, SJT, SJTW, SJTO, SJTOW (All TPE material), SPT-1, SPT-1W, NISPT-1, SPT-2, SPT-2W, NISPT-2, SPT-3, HPN, SVT, SVTO, SJT, SJTW, , SJTO, SJTOW, SV, SVO, SJ, SJO, SJOW, SJOOW, EVT, EVJT, EVE, EVJE	7 or 10/125
		17/2	SVT, SVTO (All TPE material), SVT, SVTO, SV, SVO, SJ, SJO, SJOW, SJOOW, EVT, EVJT, EVE, EVJE	12/125
		16/2	SPT-2, SPT-3, NISPT-2, SVT, SVTO, SJT, SJTW, SJTO, SJTOW (All TPE material), SPT-2, SPT-2W, NISPT-2, SPT-3,SVT, SVTO, SJT, SJTW, SJTO, SJTOW, SV, SVO, SJ, SJO, SJOW, SJOOW, EVT, EVJT, EVE, EVJE	13/125
		16/2	HPN	15/125
		14/2	SPT-3, SJT, SJTW, SJTO, SJTOW (All TPE material), SPT-3, SJT, SJTW, SJTO, SJTOW, SJ, SJO, SJOW, SJOOW, EVT, EVJT, EVE, EVJE	15/125

YP-11C	1-15	18/2	NISPT-2 (TPE), NISPT-1, NISPT-2, EVT, EVJT, EVE, EVJE	7 or 10/125
YP-12	5-15	18/3	SVT, SJT, SJTW, SJTO, SJTOW, ST, STW, STOW (Shielded and Non-shielded for all types), SVTO, SPT-2, SPT-3 (All TPE material), SVT, SVT Shielded, SVTO, SJT, SJT Shielded, SJTW, SJTW Shielded, SJTO, SJTO Shielded, SJTOW, SJTOW Shielded, SJTOOW, ST, ST Shielded, STW, STW Shielded, STOW, STOW Shielded, SV, SVO, SJ, SJ Shielded, SJO, SJO Shielded, SJOO, SJOO Shielded, SJOW, SJOW Shielded, SJOOW, SJOOW Shielded, S, SO, SO Shielded, SOO, SOO Shielded, SOW, SOW Shielded, SOOW, SOOW Shielded, SPT-2, SPT-3, EVT, EVJT, EVE, EVJE	7 or 10/125
		17/3	SVT, SVTO (All TPE material), SVT, SVTO, SV, SVO, EVT, EVJT, EVE, EVJE	12/125
		16/3	SVT, SJT, SJTW, SJTO, SJTOW, ST, STW, STOW (Shielded and Non-shielded for all types), SVTO, SPT-2, SPT-3 (All TPE material), SVT, SVT Shielded, SVTO, SJT, SJT Shielded, SJTW, SJTW Shielded, SJTO, SJTO Shielded, SJTOW, SJTOW Shielded, SJTOOW, ST, ST Shielded, STW, STW Shielded, STOW, STOW Shielded, SV, SVO, SJ, SJ Shielded, SJO, SJO Shielded, SJOO, SJOO Shielded, SJOW, SJOW Shielded, SJOOW, SJOOW Shielded, S, SO, SO Shielded, SOO, SOO Shielded, SOW, SOW Shielded, SOOW, SOOW Shielded, SPT-2, SPT-3, EVT, EVJT, EVE, EVJE	13/125
		14/3	SJT, SJTW, SJTO, SJTOW, ST, STW, STOW (Shielded and Non-shielded for all types), SPT-3 (All TPE material), SJT, SJT Shielded, SJTW, SJTW Shielded, SJTO, SJTO Shielded, SJTOW, SJTOW Shielded, SJTOOW, ST, ST Shielded, STW, STW Shielded, STOW, STOW Shielded, SJ, SJ Shielded, SJO, SJO Shielded, SJOO, SJOO Shielded, SJOW, SJOW Shielded, SJOOW, SJOOW Shielded, S, SO, SO Shielded, SOO, SOO Shielded, SOW, SOW Shielded, SOOW, SOOW Shielded, SPT-3, EVT, EVJT, EVE, EVJE, SJT-B	15/125
		12/3	SJT, SJTW, SJTO, SJTOW, ST, STW, STOW (Shielded and Non-shielded for all types), SPT-3 (All TPE material), SJT, SJT Shielded, SJTW, SJTW Shielded, SJTO, SJTO Shielded, SJTOW, SJTOW Shielded, SJTOOW, ST, ST Shielded, STW, STW Shielded, STOW, STOW Shielded, SJ, SJ Shielded, SJO, SJO Shielded, SJOO, SJOO Shielded, SJOW, SJOW Shielded, SJOOW, SJOOW Shielded, S, SO, SO Shielded, SOO, SOO Shielded, SOW, SOW Shielded, SOOW, SOOW Shielded, SPT-3, EVT, EVJT, EVE, EVJE	15/125
YP-12L	5-15	18/3	SVT, SVT shielded, SJT, SJTW, SJTO, SJTOW, ST, STW, STOW, SPT-2, SPT-3 (All TPE material), SVT, SVT shielded, SJT, SJTW, SJTO, SJTOW, ST, STW, STOW, SO, SOW, SOOW, SPT-2, SPT-3, EVT, EVJT, EVE, EVJE	7 or 10/125
		16/3	SVT, SJT, SJTW, SJTO, SJTOW, ST, STW, STOW, SPT-2, SPT-3 (All TPE material), SVT, SJT, SJTW, SJTO, SJTOW, ST, STW, STOW, SO, SOW, SOOW, SPT-2, SPT-3, EVT, EVJT, EVE, EVJE	13/125
		14/3	SJT, SJTW, SJTO, SJTOW, ST, STW, STOW, SPT-3 (All TPE material), SJT, SJTW, SJTO, SJTOW, ST, STW, STOW, SO, SOW, SOOW, SPT-3, EVT, EVJT, EVE, EVJE	15/125



	16/3	SJ, SJO, SJOW, SJOO, SJOOW, S, SO, SOW, SOO, SOOW, SJT, SJTW, SJTO, SJTOW, SJTOO, SJTOOW, ST, STW, STO, STOW, STOO, STOOO	13/125
	14/3	SJ, SJO, SJOW, SJOO, SJOOW, S, SO, SOW, SOO, SOOW, SJT, SJTW, SJTO, SJTOW, SJTOO, SJTOOW, ST, STW, STO, STOW, STOO, STOOO	15/125
	12/3	SJ, SJO, SJOW, SJOO, SJOOW, SJT, SJTW, SJTO, SJTOW, SJTOO, SJTOOW	15/125

### Special-use cord sets

Cat. No.	IEC 320 Cord Config AWG	Cord Type	Electrical Rating Amps V	
YC-11	IEC C17	18	SPT-1, SPT-2, SPT-3, NISPT-2, SVT, SJT, SJTO, SJTOW, ST, STW, STOW (All TPE material), SPT-1, SPT-2, NISPT-1, NISPT-2, SPT-3, SVT, SJT, SJTO, SJTW, SJTOW, ST, STW, STOW, SO, SOW, SOOW	2.5, 7 or 10/125 or 250
		17	SPT-3, SVT, SJT, SJTW, SJTO, SJTOW, ST, STW, STOW (All TPE material), SPT-3, SVT, SJT, SJTW, SJTO, SJTOW, ST, STW, STOW, SO, SOW, SOOW	10, 12/125 or 250
		16	SPT-2, SPT-3, NISPT-2, SVT, SJT, SJTW, SJTO, SJTOW, ST, STW, STOW (All TPE material), SPT-2, NISPT-2, SPT-3, SVT, SJT, SJTW, SJTO, SJTOW, ST, STW, STOW, SO, SOW, SOOW	13/125 or 250
YC-12, YC-12L, YC-12L-1, YC-12L-2, YC-12L-3	IEC C13	18	SVT, SJT, SJTW, SJTO, SJTOW, ST, STW, STOW (Shielded and Non-shielded for all types), SPT-2, SPT-3 (All TPE material), SVT, SJT, SJTW, SJTO, SJTOW, SJ, SJO, SJOO, SJOW, SJOOW, ST, STW, STOW, SO, SOO, SOW, SOOW (Shielded or Non-Shielded for above types), SPT-2, SPT-3	2.5, 7 or 10/125 or 250
		17	SVT, SJT, SJTW, SJTO, SJTOW, ST, STW, STOW (Shielded and Non-shielded for all types), SPT-3 (All TPE material), SVT, SJT, SJTW, SJTO, SJTOW, ST, STW, STOW, SJ, SJO, SJOO, SJOW, SJOOW, SO, SOO, SOW, SOOW (Shielded or Non-shielded for above types), SPT-3	10, 12/125 or 250
		16	SJT, SJTW, SJTO, SJTOW, ST, STW, STOW (Shielded and Non-shielded for all types), SPT-3 (All TPE material), SJT, SJTW, SJTO, SJTOW, ST, STW, STOW, SJ, SJO, SJOO, SJOW, SJOOW, SO, SOO, SOW, SOOW (Shielded or Non-shielded for above types), SPT-2, SPT-3	13/125 or 250
		15	SJT, SJTW, SJTO, SJTOW, ST, STW, STOW (Shielded and Non-shielded for all types), SPT-3 (All TPE material), SJT, SJTW, SJTO, SJTOW, ST, STW, STOW, SJ, SJO, SJOO, SJOW, SJOOW, SO, SOO, SOW, SOOW (Shielded or Non-shielded for above types), SPT-3	10, 14/125 or 250
		14	SJT, SJTW, SJTO, SJTOW, ST, STW, STOW (Shielded and Non-shielded for all types), SPT-3 (All TPE material), SJT, SJTW, SJTO, SJTOW, ST, STW, STOW, SJ, SJO, SJOO, SJOW, SJOOW, SO, SOO, SOW, SOOW (Shielded or Non-shielded for above types), SPT-3	15/125 or 250
		12	SJT, SJTW, SJTO, SJTOW, ST, STW, STOW (All TPE material, Shielded and Non-shielded for all types), SJT, SJTW, SJTO, SJTOW, ST, STW, STOW, SJ, SJO, SJOO, SJOW, SJOOW, SO, SOO, SOW, SOOW (Shielded or Non-shielded for all types)	15/125 or 250

YC-12(A.C.1)	IEC C13	12	SJT, SJTW, SJTO, SJTOW, ST, STW, STOW, SPT-3 (All TPE material), SJT, SJTW, SJTO, SJTOW, ST, STW, STOW, SO, SOW, SOOW, SPT-3	15/125 or 250
		10	SJT, SJTW, SJTO, SJTOW, ST, STW, STOW (All TPE material), SJT, SJTW, SJTO, SJTOW, ST, STW, STOW, SO, SOW, SOOW	15/125 or 250
YC-12C	IEC C13	18	NISPT-2 (TPE), NISPT-2	2.5, 7 or 10/125 or 250
		16	NISPT-2 (TPE), NISPT-2	13/125 or 250
YC-13	IEC C7	18	SPT-1, SPT-2, NISPT-2, SVT, SJT (All TPE material), SPT-1, SPT-1W, SPT-2, SPT-2W, NISPT-1, NISPT-2, SVT, SJT	2.5/250 or 7/125
YC-13W	IEC C7P	18	SPT-1, SPT-2, NISPT-2, SVT, SJT (All TPE material), SPT-1, SPT-1W, SPT-2, SPT-2W, NISPT-1, NISPT-2, SVT, SJT	2.5/250 or 7/125
YC-14	IEC C5	18	SPT-2, SVT, SVT shielded, SVTO, SJT, SJT shielded, SJTW, SJTW shielded, SJTO, SJTOW (All TPE material), SVT, SVT Shielded, SVTO, SJT, SJT Shielded, SJTW, SJTW Shielded, SJTO, SJTOW, SV, SVO, SJ, SJO, SJOW, SJOOW	2.5/250 or 7/125
			SPT-2	
YC-13L	IEC C7	18	SPT-1, SPT-2, NISPT-2, SVT, SJT (All TPE material), SPT-1, SPT-1W, SPT-2, SPT-2W, NISPT-1, NISPT-2, SVT, SJT	2.5/250 or 7/125
YC-13D	IEC C7	18	SPT-1, SPT-2, NISPT-2, SVT, SJT (All TPE material), SPT-1, SPT-1W, SPT-2, SPT-2W, NISPT-1, NISPT-2, SJT, SVT	2.5/250 or 7/125
YC-13C	IEC C7	18	NISPT-2 (All TPE material), NISPT-1, NISPT-2	2.5/250 or 7/125
YC-13E	IEC C7	18	SPT-1, SPT-2, NISPT-2, SVT, SJT (All TPE material), SPT-1, SPT-1W, SPT-2, SPT-2W, NISPT-1, NISPT-2, SVT, SJT	2.5/250 or 7/125
YC-14L, YC-14L-1, YC-14L-2, YC-14L-3	IEC C5	18	SVT, SJT, SPT-2 (All TPE material), SVT, SJT, SPT-2	2.5/250 or 7/125
YC-18	IEC C19	16	SJT, SJTW, SJTO, SJTOW, SJTOOW, ST, STW, STOW, STOOW, SPT-3 (All TPE material), SJT, SJTW, SJTO, SJTOW, SJTOOW, SJ, SJO, SJOO, SJOW, SJOOW, ST, STW, STOW, STOOW, S, SO, SOW, SOO, SOOW, SPT-3	13/125 or 250
		15	SJT, SJTW, SJTO, SJTOW, SJTOOW, ST, STW, STOW, STOOW, SPT-3 (All TPE material), SJT, SJTW, SJTO, SJTOW, SJTOOW, SJ, SJO, SJOO, SJOW, SJOOW, ST, STW, STOW, STOOW, S, SO, SOW, SOO, SOOW, SPT-3	16/125 or 250
		14	SJT, SJTW, SJTO, SJTOW, SJTOOW, ST, STW, STOW, STOOW, SPT-3 (All TPE material), SJT, SJTW, SJTO, SJTOW, SJTOOW, SJ, SJO, SJOO, SJOW, SJOOW, ST, STW, STOW, STOOW, S, SO, SOW, SOO, SOOW, SPT-3	16/125 or 250

2023年 7月27日

July 27, 2023

YUNG LI CO., LTD.  
DIRECTOR LAI WEN DA

東京都渋谷区代々木5-14-12  
一般財団法人 電気安全環境研究所  
製品認証部

5-14-12, Yoyogi, Shibuya-Ku, Tokyo  
Japan Electrical Safety & Environment technology Laboratories (JET)  
Product Certification Division

2023年 5月 8日 付けでお申込みいただきました下記の特定期間電気用品に  
つきましては、同封の適合同等証明書のとおり 2023年 8月26日付にて  
交付され、 2030年 8月25日 まで有効であることをお知らせします。

I hereby inform you that with respect to the application of May 8, 2023, for conformity assessment for the  
specified product hereunder, the certificate, as enclosed herewith, was issued on Aug 26, 2023 and the term  
of validity of this certificate is from the date of its issue to Aug 25, 2030.

### 記

1. 受付番号 : A 2 3 T 0 1 6 2

Project No.

2. 特定電気用品名 : 差込みプラグ

Name of Product

Attachment plugs

3. 製品の型 : —

Model

4. 証明書番号 : J E T 5 0 8 7 - 4 3 0 0 1 - 1 0 1 0

Statement Number

5. 製造工場名 (Manufacturer)

住所 : DAPU INDUSTRIAL ZONE, GANGZI, CHANGPING TOWN, DONGGUAN  
CITY, GUANGDONG PROVINCE, CHINA

氏名又は名称 : YUNG LI CO., LTD.

Name

6. 型式 : (Type)

125V, 7A, 極配置 II, 一体成形, 合成樹脂絶縁, 合成樹脂外郭, 差込み接続, 非  
防水型

# 適合同等証明書

Statement of Conformity Assessment

電気用品安全法第8条第1項に規定する技術基準及び同法第9条第2項の経済産業省令で定める基準（法第9条第1項第2号に係る検査に係るものに限る）に適合していることを証明します

I hereby certify that the product mentioned below complies with the technical requirements stipulated in Paragraph 1 of Article 8 of Electrical Appliances and Materials Safety Act (hereunder referred to as the Act) and the requirements defined by the ordinance of the Ministry of Economy, Trade and Industry based on Paragraph 2 of Article 9 of the Act (limited to Item 2 of Paragraph 1 of Article 9 for Inspection of the Act).

1. 証明書番号： J E T 5 0 8 7 - 4 3 0 0 1 - 1 0 1 0  
Statement Number
2. 交付年月日： 2023年 8月26日  
Effective Date August 26, 2023
3. 有効年月日： 2030年 8月25日  
Date of Validity August 25, 2030
4. 申込者名 (Applicant)  
住所 (Address) 所： DAPU INDUSTRIAL ZONE, GANGZI, CHANGPING TOWN,  
DONGGUAN CITY, GUANGDONG PROVINCE, CHINA

氏名又は名称： YUNG LI CO., LTD.  
Name

5. 特定電気用品名： 差込みプラグ  
Name of Product Attachment plugs
6. 型式の区分： 別紙のとおり  
Type Classification See attached "Type Classification"
7. 製造工場名 (Manufacturer)  
住所 (Address) 所： DAPU INDUSTRIAL ZONE, GANGZI, CHANGPING TOWN,  
DONGGUAN CITY, GUANGDONG PROVINCE, CHINA

氏名又は名称： YUNG LI CO., LTD.  
Name

8. 適用試験規格： 電気用品の技術上の基準を定める省令の解釈  
Applied Standard for Testing Description of the technical requirements by the METI Ordinance  
別表第四1、6及び別表第十 第5章

Appendix 4 Section 1, Section 6 and Appendix 10 Chapter 5

9. 適合性検査の方法： (Testing Method for Conformity Assessment)

- 1) 試験用の特定電気用品については、電気用品の技術上の基準を定める省令の解釈に定める方法

With respect to testing for Category A products, the testing method is based on the technical requirements of the description of Electrical Appliances and Materials stipulated in the METI Ordinance.

- 2) 当該特定電気用品に係る届出事業者又は事業場における検査設備については、電気用品安全法施行規則別表第四の検査設備の欄に掲げる検査設備ごとにそれぞれ同表の技術上の基準の欄に掲げる方法

With respect to inspection facilities required for Category A products at the factory, Testing Method described in the column of the technical requirements for each inspection facilities in the column of inspection facilities is shown in the Appendix 4 of Enforcement Regulations of the Act.

10. 注意事項 (Notes)

- 1) この適合同等証明書は、提出された試験用の電気用品に関して評価を行った上で交付したものであり、同一の型式の区分にある電気用品について電気用品安全法第8条1項に規定する技術基準適合確認の義務を履行したことを示すものではありません。

This Statement of Conformity Assessment, which is issued on the evaluation of the submitted test-use Electrical Appliances and Materials, does not signify that the Obligation to Comply with Requirements, which is prescribed at Paragraph 1 of Article 8 of the Act, is fulfilled on Electrical Appliances and Materials in the same Type Classification.

- 2) この適合同等証明書は、別紙に記載されている型式の区分の範囲内及び区分の組み合わせについてのみ有効です。

This Statement of Conformity Assessment is valid only for Electrical Appliances and Materials within the Type Classifications and their combination as stated in the attached "Type Classification".

一般財団法人 電気安全環境研究所  
Japan Electrical Safety & Environment Technology Laboratories (JET)

理事長 中村 幸一  
President Koichiro Nakamura

東京都渋谷区代々木5-14-12  
(5-14-12, Yoyogi, Shibuya-ku, Tokyo, Japan)

証明書番号 : J E T 5 0 8 7 - 4 3 0 0 1 - 1 0 1 0

# 適合同等証明書別紙

Statement of Conformity Assessment

## 型式の区分

Type Classification

要素 Factor	区分 Classification
定格電圧 Rated voltage	(1) 125V以下のもの 125V or less
定格電流 Rated current	(2) 3Aを超え7A以下のもの Exceeding 3A, and less than or equal to 7A
極の配置（別表第二の一 a に掲げる寸法に適合するものの場合に限る。） Pole configuration (limited to those specified in sub-clause a of Appendix 2-1)	(3) Ⅱのもの Ⅱ
極の数（別表第二の一 b に掲げる寸法に適合するものの場合に限る。） Number of poles (limited to those specified in sub-clause b of Appendix 2-1)	—
刃の取付けの方式 Blade fixing method	(1) 一体として成形されているもの Integrated type
主絶縁体の材料 Insulation materials	(1) 合成樹脂のもの Plastic
外郭の材料 Outer case materials	(2) 合成樹脂のもの Plastic
接続の方式 Connection method	(1) 差し込み型のもの（ロックナット式のものを除く。） Plug-in type (excluding those with locking nuts)
防水構造 Type of waterproof	(3) 非防水型のもの Not treated with waterproof type

証明書番号：JET5087-43001-1010

2023年 8月10日

August 10, 2023

YUNG LI CO., LTD.  
DIRECTOR LAI WEN DA

東京都渋谷区代々木5-14-12  
一般財団法人 電気安全環境研究所  
製品認証部

5-14-12, Yoyogi, Shibuya-Ku, Tokyo  
Japan Electrical Safety & Environment technology Laboratories (JET)  
Product Certification Division

2023年 5月 8日 付けでお申込みいただきました下記の特定期間用品に  
つきましては、同封の適合同等証明書のとおり 2023年 8月26日付にて  
交付され、2030年 8月25日 まで有効であることをお知らせします。

I hereby inform you that with respect to the application of May 8, 2023, for conformity assessment for the  
specified product hereunder, the certificate, as enclosed herewith, was issued on Aug 26, 2023 and the term  
of validity of this certificate is from the date of its issue to Aug 25, 2030.

### 記

1. 受付番号 : A 2 3 T 0 1 6 3

Project No.

2. 特定電気用品名 : コードコネクターボディ

Name of Product Cord connector bodies

3. 製品の型 : —

Model

4. 証明書番号 : J E T 5 0 8 7 - 4 3 0 0 4 - 1 0 0 3

Statement Number

5. 製造工場名 (Manufacturer)

住所 : DAPU INDUSTRIAL ZONE, GANGZI, CHANGPING TOWN, DONGGUAN  
CITY, GUANGDONG PROVINCE, CHINA

氏名又は名称 : YUNG LI CO., LTD.

Name

6. 型式 : (Type)

125V, 7A, 3極, 差込み接続, 合成樹脂絶縁, 合成樹脂外郭, スイッチなし, 一  
体成形, 非防水型

# 適合同等証明書

Statement of Conformity Assessment

電気用品安全法第8条第1項に規定する技術基準及び同法第9条第2項の経済産業省令で定める基準（法第9条第1項第2号に係る検査に係るものに限る）に適合していることを証明します

I hereby certify that the product mentioned below complies with the technical requirements stipulated in Paragraph 1 of Article 8 of Electrical Appliances and Materials Safety Act (hereunder referred to as the Act) and the requirements defined by the ordinance of the Ministry of Economy, Trade and Industry based on Paragraph 2 of Article 9 of the Act (limited to Item 2 of Paragraph 1 of Article 9 for Inspection of the Act).

1. 証明書番号: JET5087-43004-1003  
Statement Number
2. 交付年月日: 2023年8月26日  
Effective Date August 26, 2023
3. 有効年月日: 2030年8月25日  
Date of Validity August 25, 2030
4. 申込者名 (Applicant)  
住所 (Address): DAPU INDUSTRIAL ZONE, GANGZI, CHANGPING TOWN,  
DONGGUAN CITY, GUANGDONG PROVINCE, CHINA

氏名又は名称: YUNG LI CO., LTD.  
Name

5. 特定電気用品名: コードコネクターボディ  
Name of Product Cord connector bodies
6. 型式の区分: 別紙のとおり  
Type Classification See attached "Type Classification"
7. 製造工場名 (Manufacturer)  
住所 (Address): DAPU INDUSTRIAL ZONE, GANGZI, CHANGPING TOWN,  
DONGGUAN CITY, GUANGDONG PROVINCE, CHINA

氏名又は名称: YUNG LI CO., LTD.  
Name

8. 適用試験規格: 電気用品の技術上の基準を定める省令の解釈  
Applied Standard for Testing Description of the technical requirements by the METI Ordinance  
別表第四1、6及び別表第十 第5章

Appendix 4 Section 1, Section 6 and Appendix 10 Chapter 5

9. 適合性検査の方法: (Testing Method for Conformity Assessment)
  - 1) 試験用の特定電気用品については、電気用品の技術上の基準を定める省令の解釈に定める方法  
With respect to testing for Category A products, the testing method is based on the technical requirements of the description of Electrical Appliances and Materials stipulated in the METI Ordinance.
  - 2) 当該特定電気用品に係る届出事業者又は事業場における検査設備については、電気用品安全法施行規則別表第四の検査設備の欄に掲げる検査設備ごとにそれぞれ同表の技術上の基準の欄に掲げる方法  
With respect to inspection facilities required for Category A products at the factory, Testing Method described in the column of the technical requirements for each inspection facilities in the column of inspection facilities is shown in the Appendix 4 of Enforcement Regulations of the Act.



10. 注意事項 (Notes)

- 1) この適合同等証明書は、提出された試験用の電気用品に関して評価を行った上で交付したものであり、同一の型式の区分にある電気用品について電気用品安全法第8条1項に規定する技術基準適合確認の義務を履行したことを示すものではありません。

This Statement of Conformity Assessment, which is issued on the evaluation of the submitted test-use Electrical Appliances and Materials, does not signify that the Obligation to Comply with Requirements, which is prescribed at Paragraph 1 of Article 8 of the Act, is fulfilled on Electrical Appliances and Materials in the same Type Classification.

- 2) この適合同等証明書は、別紙に記載されている型式の区分の範囲内及び区分の組み合わせについてのみ有効です。

This Statement of Conformity Assessment is valid only for Electrical Appliances and Materials within the Type Classifications and their combination as stated in the attached "Type Classification".

一般財団法人 電気安全環境研究所  
Japan Electrical Safety & Environment Technology Laboratories (JET)

理事長 中村 幸一  
President Koichiro Nakamura

東京都渋谷区代々木5-14-12  
(5-14-12, Yoyogi, Shibuya-ku, Tokyo, Japan)

証明書番号 : J E T 5 0 8 7 - 4 3 0 0 4 - 1 0 0 3

# 適合同等証明書別紙

Statement of Conformity Assessment

## 型式の区分

Type Classification

要素 Factor	区分 Classification
定格電圧 Rated voltage	(1) 125V以下のもの 125V or less
定格電流 Rated current	(2) 3Aを超え7A以下のもの Exceeding 3A, and less than or equal to 7A
極の配置（別表第二の一aに掲げる寸法に適合するものの場合に限る。） Pole configuration (limited to those specified in sub-clause a of Appendix 2-1)	—
極の数（別表第二の一bに掲げる寸法に適合するものの場合に限る。） Number of poles (limited to those specified in sub-clause b of Appendix 2-1)	(2) アース極を含めて3のもの Three including earth
接続の方式 Connection method	(1) 差し込み型のもの（ロックナット式のものを除く。） Plug-in type (excluding those with locking nuts)
接続する電線の種類（一般固定配線用のものの場合に限る。） Type of cable or cord to be connected (limited to those for fixed wiring)	—
主絶縁体の材料 Insulation materials	(1) 合成樹脂のもの Plastic
外郭の材料 Outer case materials	(2) 合成樹脂のもの Plastic
スイッチ Switch	(2) ないもの Without switch
種類（一般固定配線用のものの場合に限る。） Type (limited to those for fixed wiring)	—
使用の方法（コンセントの場合に限る。） Method of use (limited to socket outlets)	—
電源との接続の方式（マルチタップの場合に限る。） Power supply terminals (limited to multiple socket-outlet (with cord or pins for power supply connections))	—
電線と器体との一体成形（コンセントの場合を除く。） Non-rewirable construction (except socket outlets)	(1) あるもの With non-rewirable construction
防水構造 Type of waterproof	(3) 非防水型のもの Not treated with waterproof type

証明書番号：JET5087-43004-1003



# ZJCZ7.E241374 - Flexible Cord Certified for Canada

## Flexible Cord Certified for Canada

**Yung Li Co Ltd**

Xizhi District  
7f12 No 99 Sec 1 Xintai 5th Road  
New Taipei 221416  
NEW TAIPEI, 221416 Taiwan

E241374

**Dryer and range cord** Type(s) DRT

**Jacketed cord** Type(s) S, SE, SJ, SJE, SJO, SJOO, SJOOOW, SJOW, SJT, SJT-B, SJTO, SJTOOW, SJTOW, SJTW, SO, SOO, SOOW, SOW, ST, ST-B, STO, STOW, STW, SVE, SVT, SVT-B, SVTO

**Parallel cord** Type(s) NISPE-1, NISPE-2, NISPT-1, NISPT-2, SPE-1, SPE-2, SPE-3, SPT-1, SPT-2, SPT-3

Last Updated on 2022-06-22

并不是所有出现在本数据库中的公司名称和产品都满足了UL跟踪检验服务的要求。只有带有UL标志的产品，才应该被视为经过UL认证，并满足UL跟踪检验服务的要求。注意查看产品上的标志。

UL允许在线认证目录中所含材料的复制遵循以下条件：1.指南信息、装配、构造、设计、系统和/或认证（文件）必须在不篡改任何数据（或图纸）的情况下完整且无误导性地呈现。2.“经UL允许从在线认证目录转载”声明必须出现在所摘取材料的邻近位置。此外，转载材料必须包含以下格式的版权声明：“©2022 UL LLC.”

# 適合同等証明書

Statement of Conformity Assessment

電気用品安全法第8条第1項に規定する技術基準及び同法第9条第2項の経済産業省令で定める基準（法第9条第1項第2号に係る検査に係るものに限る）に適合していることを証明します

I hereby certify that the product mentioned below complies with the technical requirements stipulated in Paragraph 1 of Article 8 of Electrical Appliances and Materials Safety Act (here under referred to as the Act) and the requirements defined by the ordinance of the Ministry of Economy, Trade and Industry based on Paragraph 2 of Article 9 of the Act (limited to Item 2 of Paragraph 1 of Article 9 for Inspection of the Act).

1. 証明書番号: JET5087-12009-1001  
Statement Number
2. 交付年月日: 2019年3月24日  
Effective Date March 24, 2019
3. 有効年月日: 2026年3月23日  
Date of Validity March 23, 2026
4. 申込者名 (Applicant)  
住 所: DAPU INDUSTRIAL ZONE, GANGZI, CHANGPING TOWN,  
Address DONGGUAN CITY, GUANGDONG PROVINCE, CHINA  
  
氏名又は名称: YUNG LI CO., LTD.  
Name
5. 特定電気用品名: キャブタイヤコード  
Name of Product Sheathed flexible cords
6. 型式の区分: 別紙のとおり  
Type Classification See attached "Type Classification"
7. 製造工場名 (Manufacturer)  
住 所: DAPU INDUSTRIAL ZONE, GANGZI, CHANGPING TOWN,  
Address DONGGUAN CITY, GUANGDONG PROVINCE, CHINA  
  
氏名又は名称: YUNG LI CO., LTD.  
Name
8. 適用試験規格: 電気用品の技術上の基準を定める省令の解釈  
Applied Standard for Testing Description of the technical requirements by the METI Ordinance  
別表第一(1), (6)及び(9)  
Appendix 1 Section 1, (1), (6) and (9)
9. 適合性検査の方法: (Testing Method for Conformity Assessment)
  - 1) 試験用の特定電気用品については、電気用品の技術上の基準を定める省令の解釈に定める方法  
With respect to testing for Category A products, the testing method is based on the technical requirements of the description of Electrical Appliances and Materials stipulated in the METI Ordinance.
  - 2) 当該特定電気用品に係る届出事業者又は事業場における検査設備については、電気用品安全法施行規則別表第四の検査設備の欄に掲げる検査設備ごとにそれぞれ同表の技術上の基準の欄に掲げる方法  
With respect to inspection facilities required for Category A products at the factory, Testing Method described in the column of the technical requirements for each inspection facilities in the column of inspection facilities is shown in the Appendix 4 of Enforcement Regulations of the Act.

## 10. 注意事項

- 1) この適合同等証明書は、提出された試験用の電気用品に関して評価を行った上で交付したものであり、同一の型式の区分にある電気用品について電気用品安全法第8条1項に規定する技術基準適合確認の義務を履行したことを示すものではありません。

This Statement of Conformity Assessment, which is issued on the evaluation of the submitted test-use Electrical Appliances and Materials, does not signify that the Obligation to Comply with Requirements, which is prescribed at Paragraph 1 of Article 8 of the Act, is fulfilled on Electrical Appliances and Materials in the same Type Classification.

- 2) この適合同等証明書は、別紙に記載されている型式の区分の範囲内及び区分の組み合わせについてのみ有効です。

This Statement of Conformity Assessment is valid only for Electrical Appliances and Materials within the Type Classifications and their combination as stated in the attached "Type Classification".

一般財団法人 電気安全環境研究所  
Japan Electrical Safety & Environment Technology Laboratories (JET)

理事長 薦田 康久  
President Yasuhisa Komoda

東京都渋谷区代々木5-14-12  
(5-14-12, Yoyogi, Shibuya-ku, Tokyo, Japan)

証明書番号 : J E T 5 0 8 7 - 1 2 0 0 9 - 1 0 0 1

# 適合同等証明書別紙

Statement of Conformity Assessment

## 型式の区分

Type Classification

要素 Factor	区分 Classification
絶縁体の主材料 Insulation materials	(1) ビニル混合物のもの Polyvinyl chloride
外装の主材料 Sheath materials	(1) ビニル混合物のもの Polyvinyl chloride
導体の種類 Conductor type	(1) A種のもの Type A
線心の構造 Core structure	(1) 同一のもの Same
耐震性 Vibration resistance	(2) ないもの Not vibration resistant
金属製の導体補強線 Metal messenger wires	(2) ないもの Without metal messenger wires

証明書番号 : J E T 5 0 8 7 - 1 2 0 0 9 - 1 0 0 1