

東莞永力電業有限公司

YUNG LI CO., LTD

Da Pu Industrial Zone, Gang Zi, Changping Town,
Dong Guan City, Guangdong 523571 China.P.R.C

TEL:0769-83396797~8

F AX:0769-83396796

E-mail: sales@yung-li.com

Description: YP-21C/YC-13

Customer: MAG

Parts No. : CB-8-BR

Draw No. :

REVISION RECORD

1		
2		
3		
4		
5		

YUNG LI		
CHECKED	PREPARED	BY

CUSTOMER	APPROVED

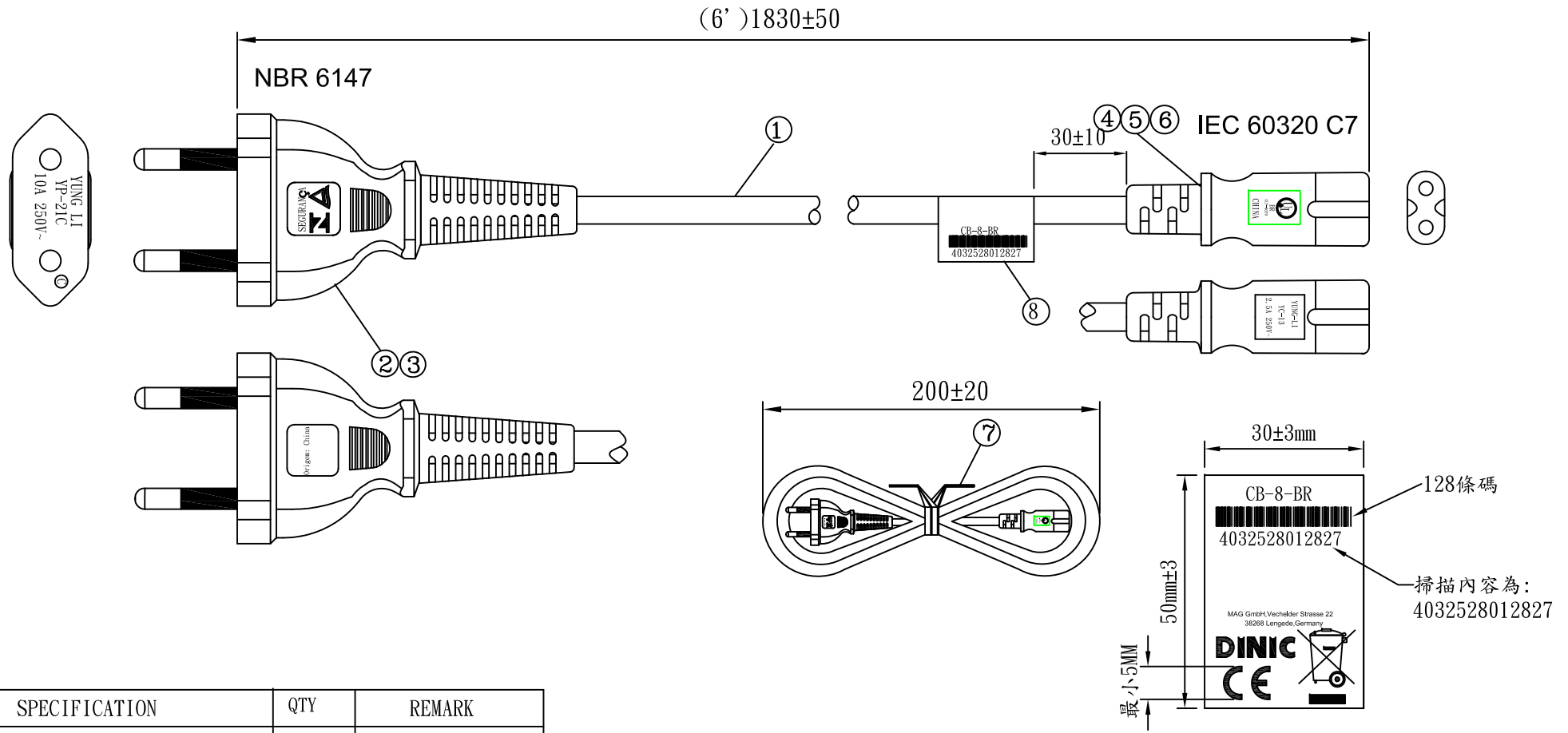

NO.	SPECIFICATION	QTY	REMARK
1	H03VVH2-F 0.75/2C BLACK	1PC	
2	2Pin plug inner model:P98058	1PC	
3	YP-21C PVC PLASTIC:50P BLACK	18g/PC	
4	YC-13 TER	2PCS	
5	YC-13 H. S. G	1PC	
6	YC-13 PVC PLASTIC:50P BLACK	9g/PC	
7	MINI TIE BLACK	1PC	
8	LABEL:50*30mm	1PC	

TOLERANCE >0±0.30 >1.0±0.50 >10.0±1.0 >20.0±2.0 Angle: ±1°	APPROVED	DATE	YUNG LI CO.,LTD					
	CHECKED	DATE						
	DRAWN	SUKI	DATE	23.07.28	CUSTOMER	MAG		
	TYPE	YP-21C/YC-13		P/N	CB-8-BR			
	DRAWING NO.	CY-B0270-09	REV	B	MATERIAL	P. V. C	UNIT	mm
					SCALE			



NBR 14136

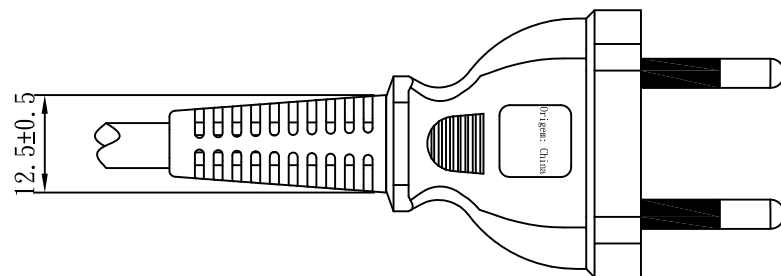
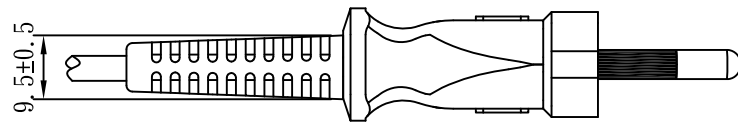
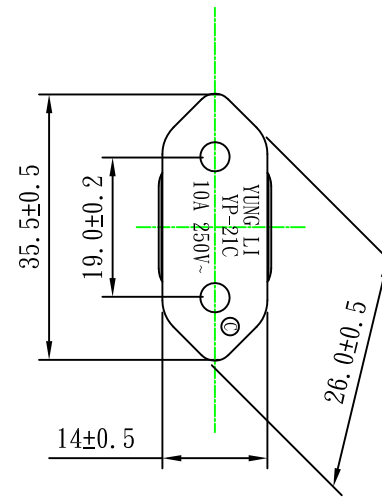
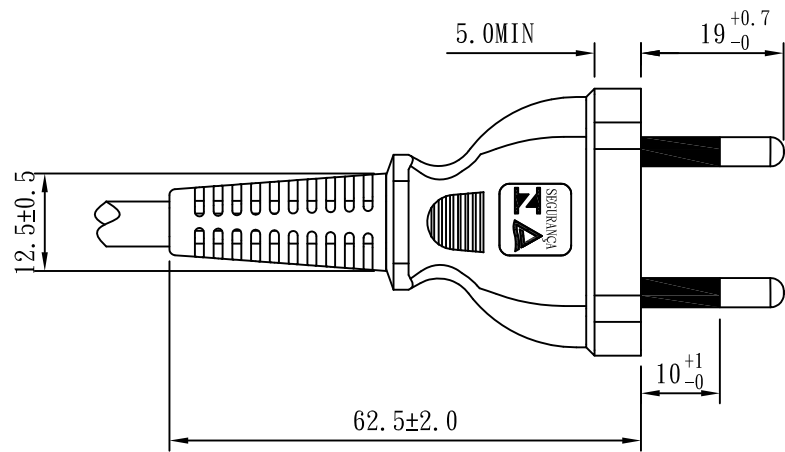

TOLERANCE >0±0.30 >1.0±0.50 >10.0±1.0 >20.0±2.0 Angle: ±1°	APPROVED		DATE		YUNG LI CO., LTD			
	CHECKED		DATE					
	DRAWN		DATE					
	TYPE	YP-21C(Brazil)			P/N			
	DRAWING NO.				SCALE	P. V. C	UNIT	mm

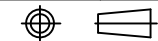

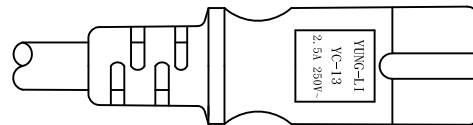
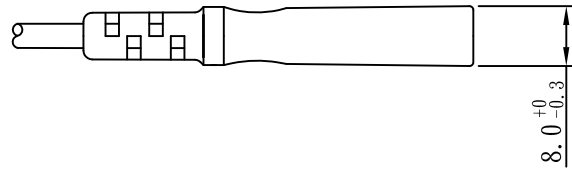
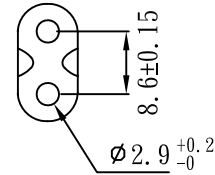
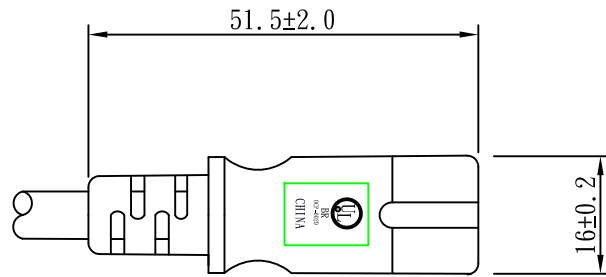

TOLERANCE >0±0.30 >1.0±0.50 >10.0±1.0 >20.0±2.0 Angle: ±1°	APPROVED		DATE		YUNG LI CO., LTD.			
	CHECKED		DATE					
	DRAWN		DATE					
	TYPE	YC-13			P/N			
	DRAWING NO.				MATERIAL	P. V. C	UNIT	mm
				SCALE	1:1			

YUNG LI CO., LTD

SPECIFICATION

Yung Li	Style	PVC FLEXIBLE CORDS	Document No
2019.04.22			CY-V04034
Edition	Size	H03VVH2-F 2 x 0.75mm²	Page
A			1/2

1. Standard: IEC 227 IEC228

2. Construction & Dimension

	Item	Specification
Conductor	Size	2 x 0.75mm ²
	Material	Annealed Bare Copper
	Construction	67 / ϕ 0.12±0.005
Insulation	Material	PVC
	Minimum Average Thickness	0.50mm
	Minimum Thickness at any point	0.35mm
	Diameter	2.15 ± 0.10
	Identification	Blue,Brown
Core Assembly	Core Twist	2-Core
	Filler	NA
	Assembly Pair	NA
Taping	Mylar Foil	NA
Shielded	A1-Mylar Foil	NA
Drain	Material	NA
	Construction	NA
Jacket	Material	PVC
	Minimum Average Thickness	0.60mm
	Minimum Thickness at any point	0.44mm
	Overall Diameter(Approx)	3.4 ± 0.1/5.6±0.15
	Color	Any Color

Marking:

Yung Li Co., Ltd. H03VVH2-F 2X0.75mm² <VDE> NF-USE 1347 (NF) KEMA-KEUR △CEBEC <OVE>
 (D) (FI) (N) (S) (S) IEMMEQU SAA-190646-EA (CCC) A004049 60227 IEC 52(RVV) 300/300V (K) SU01027-4001

YUNG LI CO., LTD

SPECIFICATION

Yung Li	Style	PVC FLEXIBLE CORDS	Document No
2019.04.22			CY-V04034
Edition	Size	H03VVH2-F 2 x 0.75mm²	Page
A			2/2

3. Electrical & Physical Properties

Item	Specification		
Rating Voltage	70°C 300V		
Conductor resistance(AT 20°C)	26.0Ω/Km MAX		
Insulation Resistance(AT 70°C)	0.010MΩ/Km Min		
Dielectric Strength	AC 2.0 KV / 15 min No Break		
Spark Test	5.0KV		
Insulation	Unaged	Tensile Strength	1500 lbs/in ² min
		Elongation	150% Min
	Aged	Tensile Strength	80~120% (80°C x168hrs)
		Elongation	80~120% (80°C x168hrs)
Jacket	Unaged	Tensile Strength	1500 lbs/in ² min
		Elongation	150% Min
	Aged	Tensile Strength	80~120% (80°C x168hrs)
		Elongation	80~120% (80°C x168hrs)
Deformation Test	70±4°C X 1hr ≤ 50%		
Cold Bend Test	-15°C x 4hr No Crack		
Heat Shock Test	150±2°C x 1hr No Crack		

Graph:

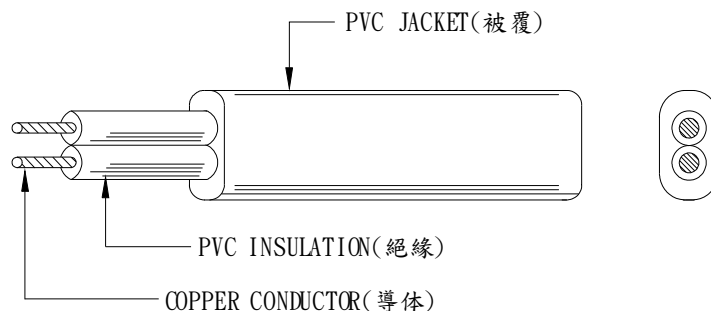

Certificado de Conformidade

Certificate of Conformity

Certificado: TÜV 20.1564
Certificate

Revisão: 02
Review

Solicitante:
Applicant

PRODUCT HOLDER CERTIFICATION SOLUTIONS LTDA
Estrada Geral, S/N - Ibituba
88780-000 – Ibituba – SC
CNPJ: 28.707.531/0001-38

Fabricante:
Manufacturer

YUNG LI CO., LTD.
Da Pu Industrial Zone – Gang Zi Chang Ping Town
Dong Guan City – Guang Dong – China – 523571

Fornecedor / Representante Legal:
Supplier / Legal Representative

Não aplicável
Non applicable

Modelo de Certificação:
Certification Model

Modelo 5 de certificação de produto conforme determina a portaria nº 90 de 09 de março de 2022 do INMETRO, com avaliação por ensaio de tipo e auditoria de fábrica iniciais e avaliação de acompanhamento a cada 6 meses com auditoria de fábrica e ensaios parciais conforme definidos no RAC.

Model 5 of product certification according to the INMETRO rule nº 90 from March 09rd, 2022, with evaluation by initial type testing and audit and maintenance evaluations every 6 months with audit and partial testing as established by the Conformity Evaluation Rule.

Regulamento / Normas:
Regulation / Standards

ABNT NBR NM 60884-1:2010;
Portaria nº 90 do INMETRO de 09/03/2022.
ABNT NBR NM 60884-1:2010;
Inmetro Decree 90 of March 09, 2022.

Produto:
Product

Plugue não desmontável 2P
Certificação por família
Non-rewirable plug 2P without earthing contact
Certification by family.

Emissão e Validade:
Issued and Validity

Emissão em: 31/08/2020.
Esta revisão é válida de 15/02/2023 até 31/08/2026.
Issue in: 08/31/2020.
This review validity from 02/15/2023 until 08/31/2026.

A validade deste Certificado de Conformidade está atrelada à realização das atividades de manutenção de acordo com os requisitos previstos no esquema de certificação específico. Para verificação da condição atualizada de regularidade deste Certificado de Conformidade deve ser consultado o banco de dados de produtos e serviços certificados do Inmetro.

The validity of this Certificate of Conformity is conditioned to the execution of the maintenance activities in accordance with the applicable requirements of the specific certification scheme. To confirm the regularity status of this Certificate of Conformity, the Inmetro's database of certified products and services must be consulted.

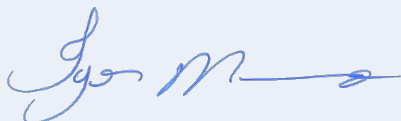

Igor Moreno
Local Field Manager



Certificado de Conformidade

Certificate of Conformity

Certificado: **TÜV 20.1564**

Certificate

Revisão: **02**

Review

Item <i>Item</i>	Marca <i>Brand</i>	Modelo / Versão <i>Model / Version</i>	Descrição <i>Description</i>	Código de Barras GTIN <i>GTIN Barcode</i>
1	YUNG LI	YP-21C PRETO <i>BLACK</i>	Plugue preto não desmontável 2P para equipamento classe II, 10A 250V~, termoplástico, conexões crimpadas, IP20, pinos maciços, com luvas isolantes, saída do cabo 180°, NBR 14136 (Figura A.13) <i>Black non-rewirable plug 2P without earthing contact for class II equipment, 10A 250V~, thermoplastic, crimped connections, IP20, solid pins, provided with insulating sleeves, cable exit 180°, NBR 14136 (Figure A.13)</i>	Não existente <i>Non-existent*</i>

* O cliente não utiliza o código de barras GTIN para comercialização do produto em território nacional.

**The client doesn't use the GTIN barcode for marketing the product in Brazil*

Laboratório, Relatório de Ensaios e Data:

Laboratory, Test Report and Date

TÜV Rheinland (Guangdong) Ltd.

50193184 001 de 29/11/2018;

50259320 001 de 30/06/2019;

50294302 001 de 08/11/2019;

60359510 001 de 20/04/2020.

50193184 001 of 11/29/2018;

50259320 001 of 06/30/2019;

50294302 001 of 11/08/2019;

60359510 001 of 04/20/2020.

Relatório de Auditoria e Data:

Audit Report and Date

50353182 001 de 25/03/2020.

50353182 001 of 03/25/2020.

Para confirmar sua autenticidade acesse <https://tuv.3dds.digital/check/46968786125946310>

Conforme art. 10, § 1º da Medida Provisória nº 2.200-2, de 24 de agosto de 2001, as declarações em forma eletrônica produzidas com a utilização de Certificação Digital disponibilizado pela (CP-Brasil) presumem-se verdadeiras em relação aos signatários, na forma do art. 219, da Lei 10.406, de 10 de janeiro de 2002 - Código Civil.

Certificado de Conformidade

Certificate of Conformity

Certificado: TÜV 20.1564
Certificate

Revisão: 02
Review

Especificações:
Description

O plugue está em conformidade com a norma ABNT NBR NM 60884-1:2010, quando provido com os seguintes cabos flexíveis:

The plug is in conformance with the standard ABNT NBR NM 60884-1:2010, if provided with the following cables:

Corrente nominal (A) <i>Nominal Current (A)</i>	Tipo de Cabo <i>Type of Cable</i>	Seção nominal (mm²) <i>Cross-Section Area (mm²)</i>
10	Cabo Flexível Circular H03VV-F 300V 60227 IEC 52 Classe 5 <i>Circular Flexible Cable H03VV-F 300V 60227 IEC 52 Class 5</i>	2x0,75
	Cabo Flexível Circular H05VV-F 500V 60227 IEC 53 Classe 5 <i>Circular Flexible Cable H05VV-F 500V 60227 IEC 53 Class 5</i>	
	Cabo Flexível Circular H05RR-F 500V 60245 IEC 53 Classe 5 <i>Circular Flexible Cable H05RR-F 500V 60245 IEC 53 Class 5</i>	
	Cabo Flexível Circular H05BQ-F 500V 60245 IEC 57 Classe 5 <i>Circular Flexible Cable H05BQ-F 500V 60245 IEC 57 Class 5</i>	
	Cabo Flexível Plano H03VVH2-F 300V 60227 IEC 52 Classe 5 <i>Flat Flexible Cable H03VVH2-F 300V 60227 IEC 52 Class 5</i>	
	Cabo Flexível Plano H05VVH2-F 500V 60227 IEC 53 Classe 5 <i>Flat Flexible Cable H05VVH2-F 500V 60227 IEC 53 Class 5</i>	
	Cabo Flexível Circular H05VV-F 500V 60227 IEC 53 Classe 5 <i>Circular Flexible Cable H05VV-F 500V 60227 IEC 53 Class 5</i>	2x1
	Cabo Flexível Plano H05VVH2-F 500V 60227 IEC 53 Classe 5 <i>Flat Flexible Cable H05VVH2-F 500V 60227 IEC 53 Class 5</i>	
	Cabo Flexível Circular H05RR-F 500V 60245 IEC 53 Classe 5 <i>Circular Flexible Cable H05RR-F 500V 60245 IEC 53 Class 5</i>	
	Cabo Flexível Circular H05BQ-F 500V 60245 IEC 57 Classe 5 <i>Circular Flexible Cable H05BQ-F 500V 60245 IEC 57 Class 5</i>	

Os cabos flexíveis aplicados devem estar em conformidade com as Normas IEC 60227, IEC 60245.

The flexible cables attached to the plug herein certified must be in compliance with the Standard IEC 60227, IEC 60245.

Este certificado está vinculado ao projeto: P00566911
This certificate is related to project

Natureza das Revisões e Data:
Nature of Reviews e Date

Revisão: 00 – 31/08/2020
Review 00 – 08/31/2020

Recertificação. Este certificado substitui e cancela o certificado de origem nº TÜV 18.1986.

Recertification. This certificate replaces and cancels the certificate of origin nº TÜV 18.1986

01 – 05/08/2022
01 – 08/05/2022

Revisão. Ajuste da validade conforme Art. 12 da Portaria nº 90 do INMETRO, publicada em 9 de março de 2022.

Review. Adjustment of validity according to Art. 12 of INMETRO Decree No. 90, published on March 09, 2022.

02 – 15/02/2023
02 – 02/15/2023

Atualização do ano da norma de referência conforme portaria do Inmetro 90/2022.

Update of the year of the reference standard according to Inmetro Decree 90/2022.

CERTIFICADO DE CONFORMIDADE

CERTIFICATE OF CONFORMITY

Certificado No. / Certificate No. 07/UL-BRAP-0010

Data de Emissão / Date of issue 27 de Setembro de 2007 / September 27, 2007

Página / Page 1 a 3

Certificado de conformidade válido somente acompanhado das páginas de 01 até 3
Certificate of conformity valid with only with pages from 1 to 3

Fornecedor solicitante / Applicant supplier **Yung Li Co Ltd**
570164 Da Pu Industrial Zone
Gangzi Chang Ping Town Dongguan, Guangdong, 523571 China

Produto certificado / Certified product CONECTORES PARA APARELHOS DE USO DOMÉSTICO E ANÁLOGO

Família de produto / Product family Conector não desmontável para equipamentos classe II

Nome do modelo / Descrição / Model Name / Description Cabo Flexível Plano / Flat Flexible Cable
60227IEC52 (H03VVH2-F) – 300/300 V
60227IEC53 (H05VVH2-F) – 300/500 V
Seção/ Cross-Section: 2x0,75mm²

Marca comercial / Trademark YC-13

Normas aplicáveis / Applicable Standards IEC 60320-1:2021
IEC 60320-3:2014

Relatório de Avaliação e Ensaios / Assessment and Test Report # BR1619/Vol.1/Sec.5

Concessão Para / Concession for **A empresa licenciada está autorizada a ostentar o Selo de Identificação de Conformidade da UL do Brasil Certificações sobre o(s) produto(s) relacionado(s) neste certificado.**
The licensed company is authorized to bear the Conformity Identification Seal of UL do Brasil Certificações on the product(s) listed in this certificate.

Revisão / Revision date 28 de setembro de 2022 / September 28, 2022
Validade / Expire date 26 de setembro de 2023 / September 26, 2023

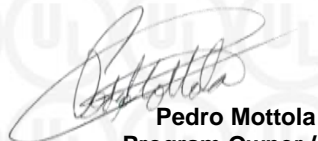
Pedro Mottola
Program Owner /

UL do Brasil Certificações confirma que o produto está em conformidade com a(s) Norma(s) e/ou Programas ou Portarias acima descritas.
UL do Brasil Certificações confirms that the product is in compliance with the standards and/or Certification Program and Ordinances above mentioned.



Organismo de Certificação / Certification Body **UL do Brasil Certificações**
Av. Engenheiro Luis Carlos Berrini, 105 – 24º andar.
04571-010 – Brooklin – São Paulo – SP – Brasil



Form-ULID-013623 - Rev.1

CERTIFICADO DE CONFORMIDADE

CERTIFICATE OF CONFORMITY

Certificado No. / Certificate No. 07/UL-BRAP-0010

Data de Emissão / Date of issue 27 de Setembro de 2007 / September 27, 2007

Página / Page 2 a 3

Certificado de conformidade válido somente acompanhado das páginas de 01 até 3
Certificate of conformity valid with only with pages from 1 to 3

Fabricante / Manufacturer **Yung Li Co Ltd**
570164 Da Pu Industrial Zone
Gangzi Chang Ping Town Dongguan, Guangdong, 523571
China

Detentor do projeto / **Yung Li Co Ltd**
Project owner Da Pu Industrial Zone
570164 Gangzi Chang Ping Town Dongguan, Guangdong, 523571 China

Título / Title	Número do relatório / Report Number	Data de emissão / Issue Date
Relatório de ensaio emitido por / Test report issued by: Laboratórios Especializados em Eletroeletrônica LABELO/PUCRS(CRL 0075)	DPC 001/2020	15/01/2020
	DPC 301/2020	15/09/2020
	DPC 134/2021	15/04/2021
	DPC 325/2021	03/09/2021
Auditoria Solicitante / Fabricante Inspection Applicant / Manufacturer		Data de Realização / Performance Date
		15/06/2021

OBSERVAÇÕES / OBSERVATIONS:

- A validade deste Certificado está condicionada à realização das avaliações de manutenção e tratamento de possíveis não conformidades de acordo com as orientações da UL do Brasil Certificações e previstas nos procedimentos específicos.**
The validation of this certificate depends on the surveillance inspections performing and Non conformity treatments, according to UL do Brasil Certificações procedures.
- Este certificado aplica-se aos equipamentos (produtos) idênticos ao protótipo avaliado e certificado, manufaturados na(s) unidade (s) fabril (is) mencionada (S) acima.**
This certificate applies to the products that are identical to the prototype investigated, certified and manufactured at the production site mentioned in this certificate
- Qualquer alteração no produto, incluindo a marcação, invalidará o presente certificado, salvo se o solicitante informar por escrito à UL do Brasil Certificações sobre esta modificação, a qual procederá à avaliação e decidirá quanto à continuidade da validade do certificado.**
Any non-authorized changes performed in the product, including marking, will invalidate this certificate. UL do Brasil Certificações must be notified about any desired change. This notification will be analyzed by UL do Brasil Certificações that will decide about certificate force.

Organismo de Certificação /
Certification Body

UL do Brasil Certificações

Av. Engenheiro Luis Carlos Berrini, 105 – 24º andar.
04571-010 – Brooklin – São Paulo – SP – Brasil



Form-ULID-013623 - Rev.1

CERTIFICADO DE CONFORMIDADE

CERTIFICATE OF CONFORMITY

Certificado No. / Certificate No. 07/UL-BRAP-0010

Data de Emissão / Date of issue 27 de Setembro de 2007 / September 27, 2007

Página / Page 3 a 3

Certificado de conformidade válido somente acompanhado das páginas de 01 até 3
Certificate of conformity valid with only with pages from 1 to 3

INFORMAÇÕES COMPLEMENTARES / SUPPLEMENTARY INFORMATION:

Marca/ Trade Mark	Descrição das Versões do Modelo / Model Versions Description	
YC-13	Plugue conector para 2,5 A 250 V para equipamento classe II Figura C7, para temperaturas do pino em condições frias não excedendo a 70° C, saída do cabo: 180°. Plug Connector for 2,5 A 250 V for class II Equipment Figure C7, for cold conditions pin temperature not exceeding 70 °C, cable exit: 180°.	
	Cabos utilizados / Cables used:	Características Nominais / Nominal characteristics
	Cabo Flexível Plano / Flat Flexible Cable 60227IEC52 (H03VVH2-F) – 300/300 V 60227IEC53 (H05VVH2-F) – 300/500 V Seção/ Cross-Section: 2x0,75mm ²	2,5 A 250V ~

1. Histórico de revisões / Revision description:

27 de Setembro de 2007 / September 27, 2007	Emissão inicial / Initial Emission
17 de Setembro de 2009 / September 17, 2009	Revisão Automática / Automatic Review
21 de Setembro de 2011 / September 21, 2011	Revisão Automática e Atualização do Formato / Automatic Review and Format Update
09 de Setembro de 2013 / September 09, 2013	Revisão Automática e Atualização do Formato / Automatic Review and Format Update
24 de Setembro de 2015 / September 24, 2015	Revisão Automática / Automatic Review
30 de Outubro de 2017 / October 30, 2017	Renovação de Certificado / Renewal Certificate
31 de Outubro de 2017 / October 31, 2017	Revisão do Template do Certificado / Certificate Template Revision
16 de Outubro de 2019 / October 16, 2019	Renovação de Certificado / Renewal Certificate
28 de Setembro de 2021 / September 28, 2021	Renovação de Certificado / Renewal Certificate
18 de Novembro de 2021 / November 18, 2021	Revisão da tabela de versões dos modelos / Review of the model version table
28 de Setembro de 2022 / September 28, 2022	Correção e inclusão do ano da norma/ Correction and inclusion the standard year
A última revisão substitui e cancela as anteriores The last review cancel and substitutes the previous ones	

Organismo de Certificação /
Certification Body

UL do Brasil Certificações

Av. Engenheiro Luis Carlos Berrini, 105 – 24º andar.
04571-010 – Brooklin – São Paulo – SP – Brasil



Form-ULID-013623 - Rev.1

ZEICHENGENEHMIGUNG MARKS APPROVAL

Yung-Li Co. Ltd.
Da Pu Industrial Zone, Cang Zi
Chang Ping Town
523571 DONG GUAN CITY
Guangdong
CHINA

ist berechtigt, für ihr Produkt /
is authorized to use for their product

Starkstromleitungen für allgemeine Anwendungen
- Flexible Leitungen
mit thermoplastischer PVC-Isolierung
Cables for general applications
- Flexible cables with
thermoplastic PVC insulation

die hier abgebildeten markenrechtlich geschützten Zeichen
für die ab Blatt 2 aufgeführten Typen zu benutzen /
the legally protected Marks as shown below for the types referred to on page 2 ff.

◁VDE▷ oder/or ◁▷⊠▷ oder/or  schwarz
black rot
red

Geprüft und zertifiziert nach /
Tested and certified according to

DIN EN 50525-2-11 (VDE 0285-525-2-11):2012-01; EN 50525-2-11:2011



Aktenzeichen: 1609800-5140-0005 / 211124

File ref.:

Ausweis-Nr. 40010145

Blatt 1

Certificate No.

Page

Weitere Bedingungen siehe Rückseite und Folgeblätter /
further conditions see overleaf and following pages

Offenbach, 2004-04-27

(letzte Änderung / updated 2015-05-26)

VDE Prüf- und Zertifizierungsinstitut GmbH
VDE Testing and Certification Institute
Zertifizierungsstelle / Certification

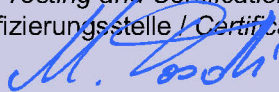

M. Tasotti

VDE Zertifikate sind nur gültig bei Veröffentlichung unter:
VDE certificates are valid only when published on:

<http://www.vde.com/zertifikat>
<http://www.vde.com/certificate>

Name und Sitz des Genehmigungs-Inhabers / *Name and registered seat of the Certificate holder*

Yung-Li Co. Ltd., Da Pu Industrial Zone, Cang Zi, Chang Ping Town, 523571 DONG GUAN CITY, Guangdong, CHINA

Aktenzeichen / *File ref.*

1609800-5140-0005 / 211124 / CC5 / HEG

letzte Änderung / *updated*

2015-05-26

Datum / *Date*

2004-04-27

Dieses Blatt gilt nur in Verbindung mit Blatt 1 des Zeichengenehmigungsausweises Nr. 40010145.

This supplement is only valid in conjunction with page 1 of the Certificate No. 40010145.

Starkstromleitungen für allgemeine Anwendungen - Flexible Leitungen mit thermoplastischer PVC-Isolierung *Cables for general applications - Flexible cables with thermoplastic PVC insulation*

Typ(en) / *Type(s)*

H03VV-F 2...4 x 0,5...0,75 mm ²	+
H03VVH2-F 2 x 0,5...0,75 mm ²	+
H05VV-F 2...5 x 0,75...4 mm ²	+
H05VVH2-F 2 x 0,75...1,0 mm ²	+

Leitungsbauart
Type of cable

Standardleitungen
General purpose cables

Firmenzeichen
Trademark

Yung Li Co., Ltd.

Dieser Zeichengenehmigungs-Ausweis bildet eine Grundlage für die EG-Konformitätserklärung und CE-Kennzeichnung durch den Hersteller oder dessen Bevollmächtigten und bescheinigt die Konformität mit den grundlegenden Schutzanforderungen der **EG-Niederspannungsrichtlinie 2006/95/EG** mit ihren Änderungen.
*This Marks Approval is a basis for the EC Declaration of Conformity and the CE Marking by the manufacturer or his agent and proves the conformity with the essential safety requirements of the **EC Low-Voltage Directive 2006/95/EC** including amendments.*

VDE Prüf- und Zertifizierungsinstitut GmbH
VDE Testing and Certification Institute
Fachgebiet CC5
Section CC5

VDE Prüf- und Zertifizierungsinstitut Zeichengenehmigung

Ausweis-Nr. / Beiblatt /
Certificate No. Supplement
40010145

Name und Sitz des Genehmigungs-Inhabers / *Name and registered seat of the Certificate holder*

Yung-Li Co. Ltd., Da Pu Industrial Zone, Cang Zi, Chang Ping Town, 523571 DONG GUAN CITY, Guangdong, CHINA

Aktenzeichen / *File ref.*

1609800-5140-0005 / 211124 / CC5 / HEG

letzte Änderung / *updated*

2015-05-26

Datum / *Date*

2004-04-27

Dieses Beiblatt ist Bestandteil des Zeichengenehmigungsausweises Nr. 40010145.

This supplement is part of the Certificate No. 40010145.

Starkstromleitungen für allgemeine Anwendungen - Flexible Leitungen mit thermoplastischer PVC-Isolierung

***Cables for general applications
- Flexible cables with
thermoplastic PVC insulation***

Fertigungsstätte(n)

Place(s) of manufacture

Referenz/*Reference*
30008928

Yung-Li Co. Ltd.
Da Pu Industrial Zone, Cang Zi
Chang Ping Town
523571 DONG GUAN CITY
Guangdong
CHINA

VDE Prüf- und Zertifizierungsinstitut GmbH
VDE Testing and Certification Institute
Fachgebiet CC5
Section CC5

Name und Sitz des Genehmigungs-Inhabers / *Name and registered seat of the Certificate holder*

Yung-Li Co. Ltd., Da Pu Industrial Zone, Cang Zi, Chang Ping Town, 523571 DONG GUAN CITY, Guangdong, CHINA

Aktenzeichen / *File ref.*

1609800-5140-0005 / 211124 / CC5 / HEG

letzte Änderung / *updated*

2015-05-26

Datum / *Date*

2004-04-27

Dieses Blatt gilt nur in Verbindung mit Blatt 1 des Zeichengenehmigungsausweises Nr. 40010145.

This supplement is only valid in conjunction with page 1 of the Certificate No. 40010145.

Genehmigung zum Benutzen des auf Seite 1 abgebildeten markenrechtlich geschützten Zeichens des VDE:

Grundlage für die Benutzung sind die Allgemeinen Geschäftsbedingungen (AGB) der VDE Prüf- und Zertifizierungsinstitut GmbH (www.vde.com\AGB-Institut). Das Recht zur Benutzung erstreckt sich nur auf die bezeichnete Firma mit den genannten Fertigungsstätten und die oben aufgeführten Produkte mit den zugeordneten Bezeichnungen. Die Fertigungsstätte muss so eingerichtet sein, dass eine gleichmäßige Herstellung der geprüften und zertifizierten Ausführung gewährleistet ist.

Die Genehmigung ist so lange gültig wie die VDE-Bestimmungen gelten, die der Zertifizierung zugrunde gelegen haben, sofern sie nicht auf Grund anderer Bedingungen aus der VDE Prüf- und Zertifizierungsordnung (PM102) zurückgezogen werden muss.

Der Gültigkeitszeitraum einer VDE-GS-Zeichengenehmigung kann auf Antrag verlängert werden. Bei gesetzlichen und / oder normativen Änderungen kann die VDE-GS-Zeichengenehmigung ihre Gültigkeit zu einem früheren als dem angegebenen Datum verlieren.

Produkte, die das Biozid Dimethylfumarat (DMF) enthalten, dürfen gemäß der Kommissionsentscheidung 2009/251/EG nicht mehr in den Verkehr gebracht oder auf dem Markt bereitgestellt werden.

Der VDE-Zeichengenehmigungsausweis wird ausschließlich auf der ersten Seite unterzeichnet.

Approval to use the legally protected Mark of the VDE as shown on the first page:

Basis for the use are the general terms and conditions of the VDE Testing and Certification Institute (www.vde.com\terms-institute). The right to use the mark is granted only to the mentioned company with the named places of manufacture and the listed products with the related type references. The place of manufacture shall be equipped in a way that a constant manufacturing of the certified construction is assured.

The approval is valid as long as the VDE specifications are in force, on which the certification is based on, unless it is withdrawn according to the VDE Testing and Certification Procedure (PM102E).

The validity period of a VDE-GS-Mark Approval may be prolonged on request. In case of changes in legal and / or normative requirements, the validity period of a VDE-GS-Mark Approval may be shortened.

Products containing the biocide dimethylfumarate (DMF) may not be marketed or made available on the EC market according to the Commission Decision 2009/251/EC.

The approval is solely signed on the first page.